

Glass Passivated Fast Recovery Rectifiers
Reverse Voltage 50 to 1000 Volts, Forward Current 2.0 Amperes

Features

- Low forward voltage drop
- High current capability
- High reliability
- High surge current capability

Mechanical Data

- Case : Molded plastic DO-15 (DO-204AC)
- Epoxy : UL 94V-O rate flame retardant
- Terminals : Axial leads, solderable per MIL-STD-202, method 208 guaranteed
- Polarity : Color band denotes cathode end
- High temperature soldering guaranteed : 260°C/10 seconds /0.375", (9.5mm) lead lengths at 5lbs., (2.3kg) tension
- Weight : 0.4 gram

Marking

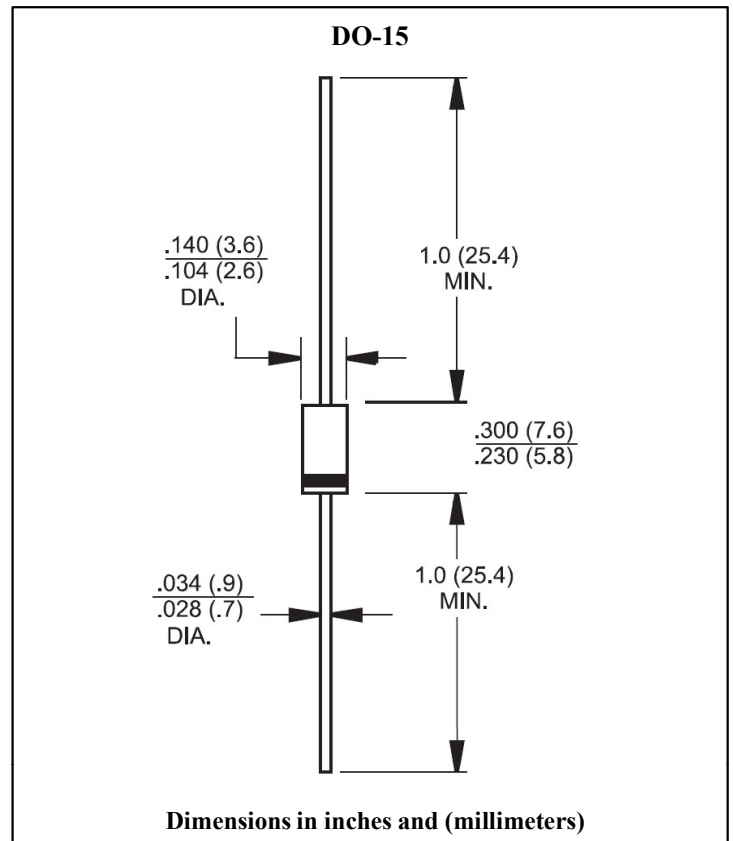
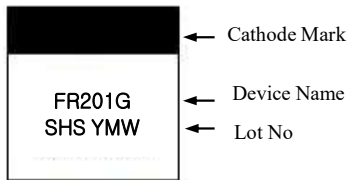

Maximum Ratings & Electrical Characteristics

Ratings at 25°C ambient temperature unless otherwise specified
 Single phase half wave 60 HZ, resistive or inductive load
 For capacitive load, derate current by 20%

Parameter	Symbol	FR 201G	FR 202G	FR 203G	FR 204G	FR 205G	FR 206G	FR 207G	Unit	Remark
Maximum Repetitive Peak Reverse Voltage	V_{RRM}	50	100	200	400	600	800	1000	V	
Maximum RMS Voltage	V_{RMS}	35	70	140	280	420	560	700	V	
Maximum DC Blocking Voltage	V_{DC}	50	100	200	400	600	800	1000	V	
Maximum Average Forward Rectified Current 0.375" (9.5mm) Lead Length	$I_{F(AV)}$	2.0							A	
Peak Forward Surge Current, 8.3 ms Single Half Sine-wave Superimposed on Rated Load (JEDEC Method)	I_{FSM}	55							A	
Maximum Instantaneous Forward Voltage @ 2.0A	V_F	1.3							V	
Maximum DC Reverse Current at Rated DC Blocking Voltage	I_R	5.0							uA	Ta=25°C
		100							uA	Ta=125°C
Maximum Reverse Recovery Time	t_{rr}	150			250	500			ns	Note 1
Typical Junction Capacitance	C_J	20							pF	Note 2
Operation Junction Temperature Range	T_J	-55 to +150							°C	
Storage Temperature Range	T_{STG}	-55 to +150							°C	

Note 1. Reverse Recovery Test Conditions : $I_F=0.5A$, $I_R=1.0A$, $I_{RR}=0.25A$
 Note 2. Measured at 1MHz and Applied Reverse Voltage of 4.0Volts D.C.

Ratings and Characteristics Curves ($T_a=25^\circ\text{C}$ unless otherwise noted)

Fig.1 Forward Current Derating Curve

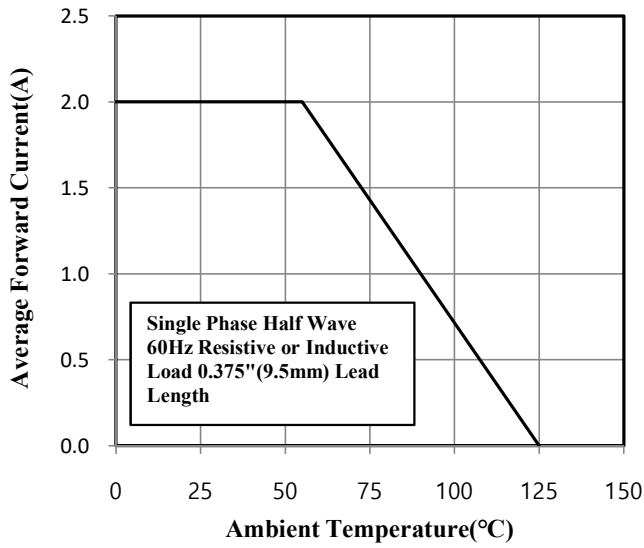

Fig.2 Maximum Non-Repetitive Peak Forward Surge Current

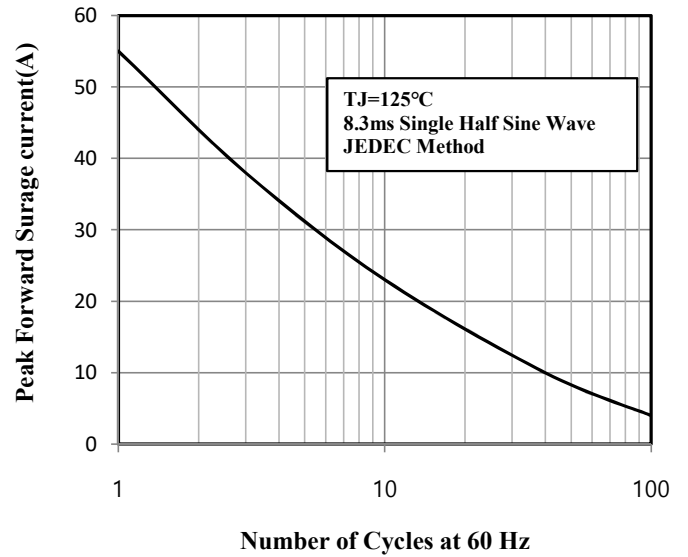

Fig.3 Typical Instantaneous Forward Characteristics

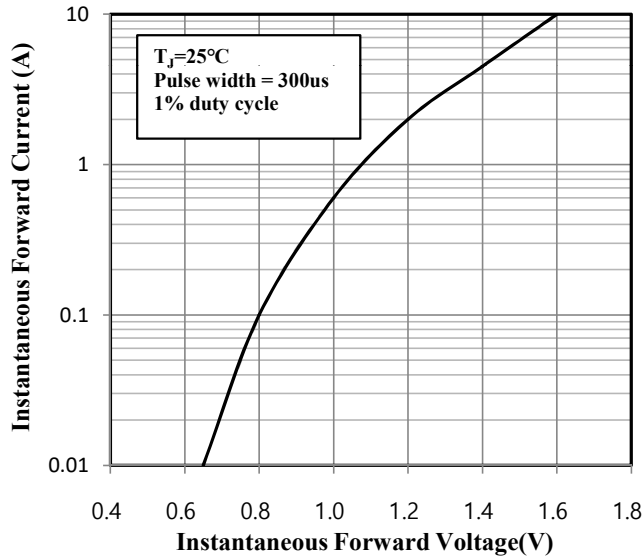

Fig.4 Typical Junction Capacitance

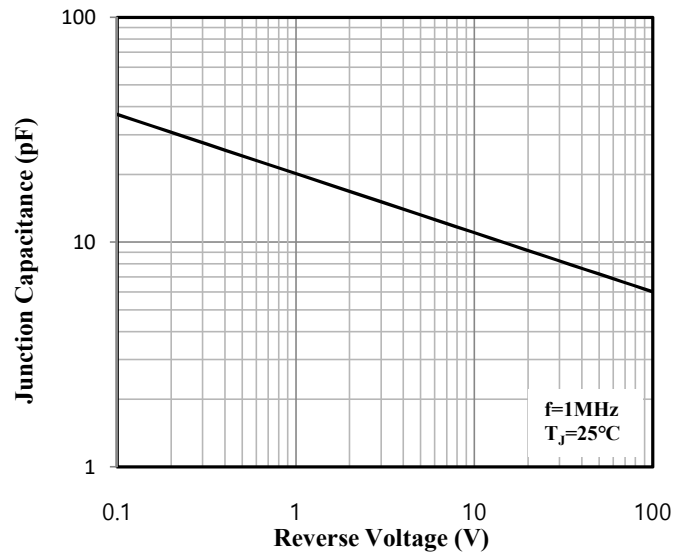
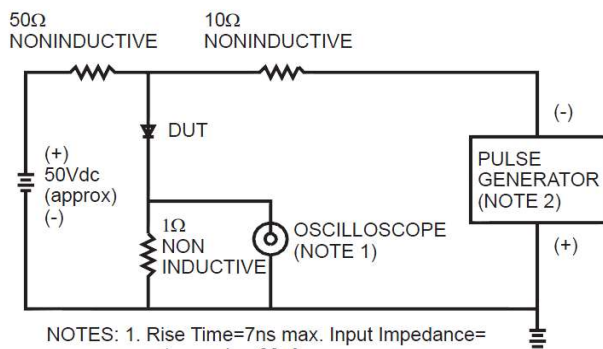

Fig.5 Reverse Recovery Time Characteristic and Test Circuit Diagram



NOTES: 1. Rise Time=7ns max. Input Impedance=1 megohm 22pf
2. Rise Time=10ns max. Source Impedance=50 ohms

